

164820  
TWO ARM SOFA

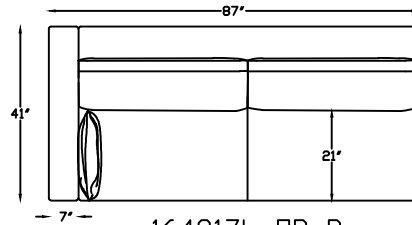

164817L OR R  
ONE-ARM SOFA  
(SHOWN AS LEFT)

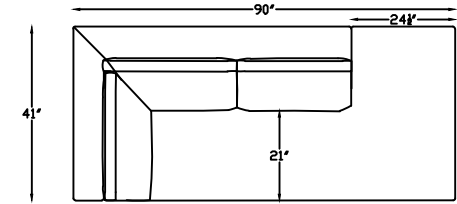

164853R OR L  
RETURN SOFA W/ BUMPER  
(SHOWN AS RIGHT)

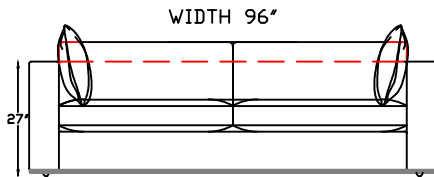

\*FRONT VIEW

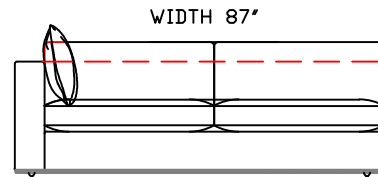

\*FRONT VIEW

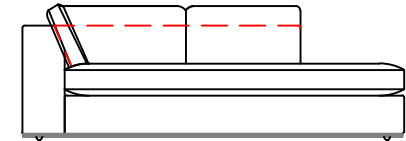

\*FRONT VIEW

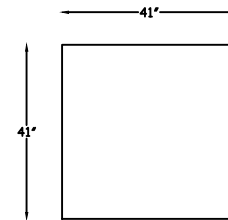

164801  
OTTOMAN

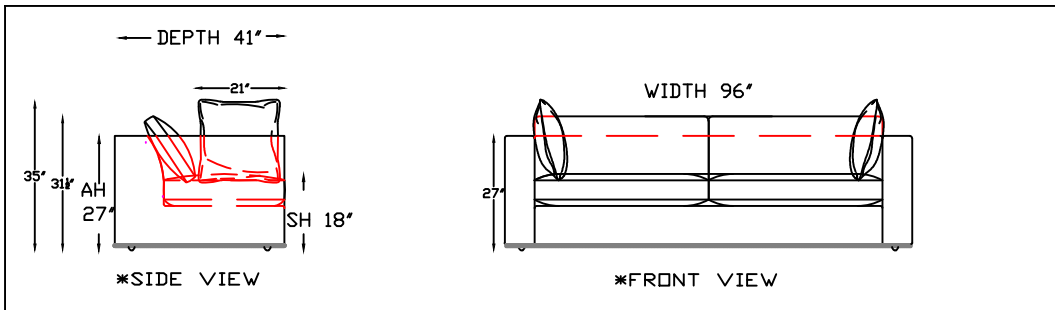

\*SIDE VIEW

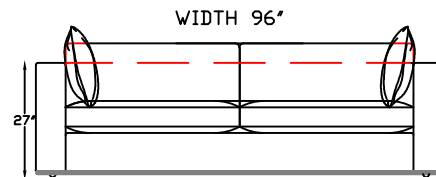

\*FRONT VIEW

This schematic is current as of February 21, 2022  
 Lazar reserves the right to change dimensions and/or products offered.  
 A more recent schematic may be available for this series at [www.lazarind.com](http://www.lazarind.com)  
 NOTE: L or R is determined by facing the piece.